

Instruction Manual

MSK 25

Satellite/TV/FM

Test Receiver

analogue/digital



KATHREIN

Antennen · Electronic

Preface

Dear customer,

The KATHREIN-Werke KG has done its utmost to guarantee the correctness and completeness of this manual. However, no liability can be assumed for any potential errors in this manual and any damages thereby resulting.

This manual may not be copied or else be duplicated, neither as a whole, nor in extracts, without the written consent of the KATHREIN-Werke KG.

This manual is subject to modifications and amendments without prior notice. This in particular applies to modifications which suit the technical progress.

All product names and trademarks in this manual are the property of the respective firms.

All rights reserved.

Validity: This manual applies for the MSK 25. Date of issue: Sept. 2005

Contents

Preface	2
Contents	3
General Information	5
Signs and Symbols	5
Safety Rules	5
Functionality	6
Overview of Functions	7
Technical Data	9
Control Elements and Indicators	11
Control Elements.....	11
TFT Colour Screen.....	11
Connections (right hand side).....	11
Short Cut Overview	12
Connections	13
RF Input Socket	13
External DC Voltage Supply	13
Scart Output.....	13
RS 232 Interface.....	13
Commissioning	14
Switching-Up.....	14
Switching-Off.....	14
Setup-Menu.....	15
Factory Setting on Delivery	15
Setup Menu Setting.....	15
Setup Menu Call-Up	15
Mains Operation and Battery Operation	16
Mains Operation	16
Battery Operation	16
SAT measurement	17
Standard Change-Over.....	17
Frequency Display and Frequency Entry.....	18
SAT Menu Frequency Entry	18
SAT Analogue Level Measurement.....	19
Level Overflow and Level Underflow.....	19
SAT DVB-S Level Measurement	19
Locating Satellites.....	20
Bearing for Individual Reception Frequencies.....	21
SAT Analogue Sound Carrier Frequency	22
DVB-S MER, BER and Offset Measurement.....	23
MPEG Picture Representation (option) in DVB-S.....	23
LNB Voltage and 22 kHz/60 Hz Change-Over	24
DiSEqC™ (Digital Satellite Equipment Control)	26
Framing Byte Menu	27
Address Byte Menu	28
Command Byte Menu.....	29
Data Byte Menu.....	31
Simple Tone Burst DiSEqC™	31
TV measurement	32
Standard Change-Over.....	32
DVB-C/DVB-T Change-Over	33
Channel display and channel entry.....	34
Frequency Display and Frequency Entry.....	35
Level Measurement TV Analogue.....	36
Level Overflow and Level Underflow.....	36
TV/DVB-C/DVB-T Level Measurement.....	36
Bearing for Individual Reception Frequencies	37
Sound Carrier Distance and Sound Carrier Level	38
NICAM Sound Bit Error Rate Measurement.....	39
DVB-C/DVB-T (option), MER, BER and Offset Measurement.....	40

Contents

MPEG Picture Representation (option) in DVB-C or DVB-T (option)	40
FM measurement	41
Frequency Indication and Frequency Entry	41
Level Measurement.....	42
Level Overflow and Level Underflow.....	42
Bearing for Individual Reception Frequencies	43
Spectrum Measurement	44
SAT Spectrum	44
TV Spectrum	44
FM Spectrum.....	45
Maintenance	46
Changing the Battery	46
Customer Service	46
Technical Appendix	47
Signal-to-Noise-Ratio	47
DiSEqC™ Commands for Kathrein Matrices	48
Instruction Set for 9xx Kathrein Matrix Production Run	48
Instruction Set for EXR 20 Kathrein Matrix	48
Instruction Set for EXR 22 Kathrein Matrix	48
Channel Tables	49
Channel Table and Frequency Table B/G Standard (frequencies in MHz).....	49
Channel Table and Frequency Table L Standard (frequencies in MHz).....	50
Channel Table and Frequency Table D/K Standard (frequencies in MHz).....	51
Channel Table and Frequency Table I Standard (frequencies in MHz).....	52
Channel Table and Frequency Table M1 Standard (Japan) (frequencies in MHz)	53
Channel Table and Frequency Table M/N Standard (frequencies in MHz)	54
Channel Table and Frequency Table M/N Standard (frequencies in MHz)	55

General Information

This user manual has been compiled for persons with some electrical engineering ability and knowledge. Users who have already operated similar measuring instruments can obtain the necessary commands for each operating step from the overview. In addition, the following examples will help you understand each operating step.

Signs and Symbols



Always adhere to the instructions classified with the warning signal carefully, as otherwise the MSK 25 test receiver may be damaged or even be destroyed.



This symbol provides information on measuring functions and refers to chapters containing further particulars on a subject.



This symbol is followed by an example of the measuring function explained.



Find an overview of the commands for the germane short cut for the particular measuring function.

[key]

Key on the instrument to be pressed.

Safety Rules



Careful observance of the VDE safety instructions is essential!
Only fuses with the same power-down characteristics are to be used!
On feeding in signals, heed the allowable peak levels!
• HF input: max. 120 dB μ V (60 dBmV)!
• Do not connect direct-current (DC) voltage to the RF socket!
Do not connect low frequency alternating-current (AC) voltage to the RF socket!
The instrument is also energised when disconnected!
Use only the power supply unit provided for voltage feed!
Depending on the programming, between 5 V and 20 V may be connected to the RF input socket. From 10 V to 20 V, up to 500 mA can be obtained from the source, and up to 100 mA can be obtained from 5 V to 9.9 V.

Additionally included in Delivery

- 1 Wall power supply
- 1 BNC measuring cable
- 1 Adapter BNC socket – F socket
- 1 Adapter BNC socket – F plug
- 1 Adapter BNC socket – IEC socket
- 1 Adapter BNC socket – IEC plug
- 1 20 dB attenuation plug with d.c. voltage passage
(Find indications on the frequency response of the enclosed attenuation plug on the last page)



Electronic equipment is not household waste - in accordance with directive 2002/96/EC OF THE EUROPEAN PARLIAMENT AND THE COUNCIL of 27th January 2003 on used electrical and electronic equipment, it must be disposed of properly.
At the end of its service life, take this unit for disposal at a relevant official collection point.

The MSK 25 has been conceived as a portable test receiver for TV, SAT and FM radio measurements, as well as for DVB-C, DVB-S and DVB-T in both, battery operation and mains operation. The built-in lead battery (3.4 Ah) and a wall power supply with a built-in charger, suitable for 230 VAC, are included in delivery.

Controlling and scanning of the console and the display of frequency and level on the LCD are carried out by a microcontroller. The receiving frequency is indicated in MHz. Levels are measured with a peak value detector or with an average value detector and indicated digitally in dB μ V or dBmV. Correction values are determined when the levels are calibrated for the MSK 25 and stored in EEPROM. Thus, precise level measurement readings can be recorded.

A bargraph display is provided to help locate transmitters. In addition, a level-dependent acoustic signal facilitates the antenna alignment. The display need not be observed.

The audio part with its built-in loudspeaker can process and reproduce the various Sat and TV-NF signals complying with the B/G, D/K, I, M1 (JAPAN) and M/N standards, as well as with the FM audio signals and the DVB-C-, DVB-T- and DVB-S signals (if the instrument provides MPEG or DVB-T respectively). NICAM and AM sound reproduction (L standard) is also possible.

The LNB supply voltage of 20 V /, max. 500 mA, with a graduation of 0.1 V, as well as the superimposition of 22 kHz / 60 Hz and the option to send DiSEqC™ commands or Simple-DiSEqC™ commands, cover all currently known specifications. In DVB-T mode, you can obtain antenna feed voltage between 5 V and 9.9 V, max. 100 mA, from the RF socket.

The built-in TFT colour screen allows the screening and evaluation of analogue TV and SAT signals on the spot. If MPEG option is provided, also digital signals can be displayed.

Overview of Functions

Function	Analogue SAT mode	Analogue TV mode	Analogue FM mode	DVB-S mode	DVB-C mode	Option DVB-T mode
Mains operation and battery operation	*	*	*	*	*	*
Level measurement by frequency setting	*	*	*	*	*	*
Level measurement by channel setting					*	*
Level-dependent acoustic signal	*	*	*	*	*	*
Spectrum display	*	*	*	*	*	*
Loudspeaker for acoustics control	*	*	*	Option MPEG	Option MPEG	Option MPEG
Multiple standards reception (B/G, D/K, I, L, Nicam, M/N, M1) Nicam audio reception and L standard	*	*	*	QPSK	QAM 64, QAM 128	COFDM 2k, 8k
Sound storage medium setting	*	*				
Sound storage medium measurement		*				
LNB external feeding power supply tunable LNB external feeding current measurement	*	*	*	*	*	*
22 kHz / 60 Hz change-over	*			*	*	*
DiSEqC™, Simple DiSEqC™	*	*	*	*	*	*
DVB level measurement				*	*	*
DVB-MER-BER measurement				*	*	*
DVB displaying				Option MPEG	Option MPEG	Option MPEG
Scart output (video and audio)	*	*	* (audio)	Option MPEG	Option MPEG	Option MPEG
Nicam tone, reception and bit error rate measurement		*				

MSK25

24.06.03 / OH / JK

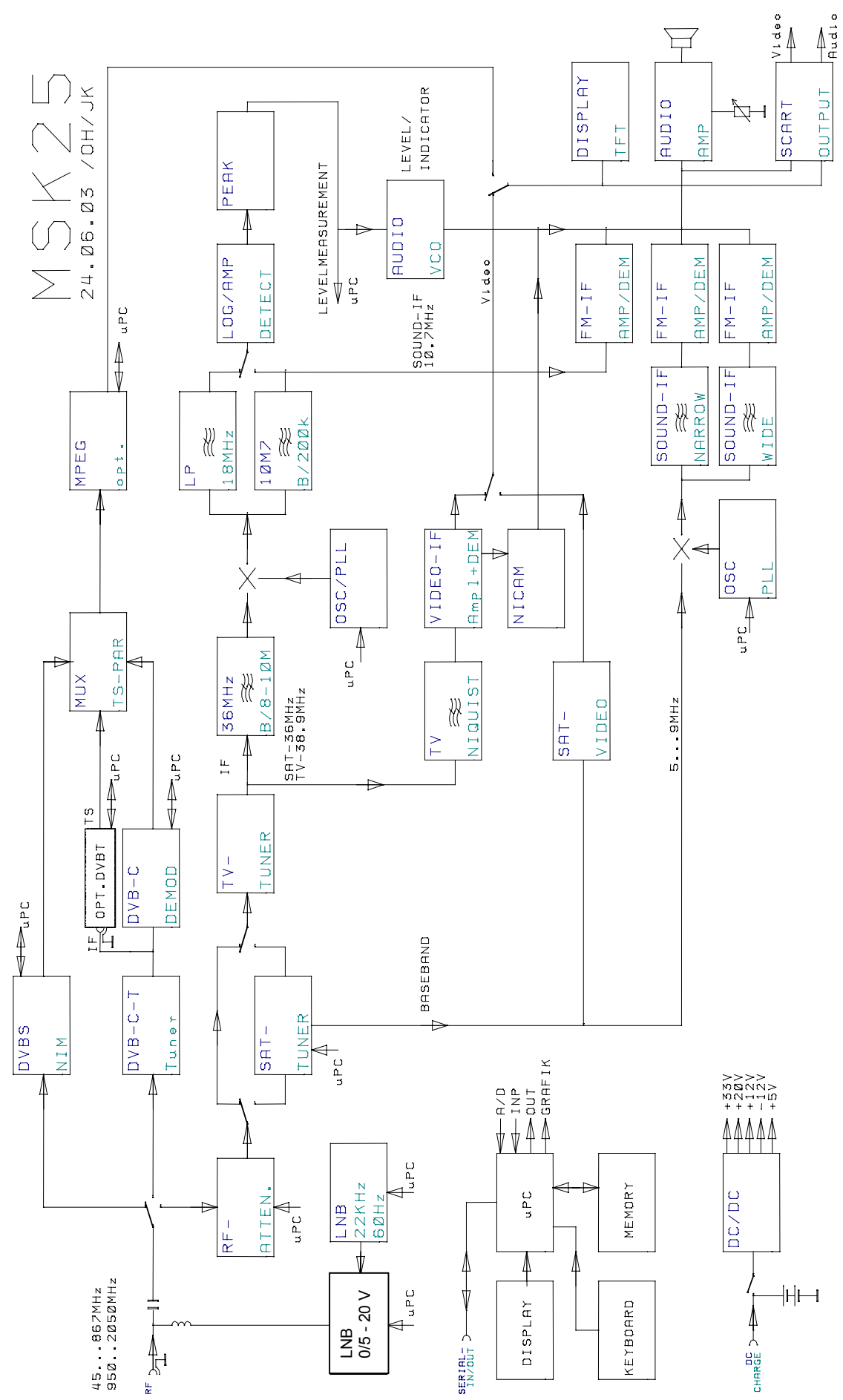

Technical Data

Power supply					
Mains operation			230 VAC, 50/60 Hz		
Battery operation			Lead Battery 12 V/3.4 Ah		
Dimensions			Width 260 mm, Height 90 (120) mm, Depth 165 mm incl. accessories (plus case)		
Weight			ca. 4.5 kg (incl. case)		
Safety standards			CE mark Protection class II VDE EN 61010		
Display			TFT screen, LCD alpha numeric, 2x16 characters, Bargraph display, backlit		
Temperature range			+5 C to +45 C		
Frequency range	SAT		920 MHz...2150 MHz		
	TV		48 MHz...858 MHz		
	FM		88 MHz...108 MHz (48 MHz...858 MHz)		
Channel configuration		TV	B standard	7 MHz	
		D/G/I/K standard		8 MHz	
		M/N/M1 standard		6 MHz	
Frequency tuning	SAT		0.125 MHz graduations		
	TV		50 kHz graduations		
	FM		50 kHz graduations		
Measurement error	SAT		Max. ± 2 dB		
	TV/FM		Max. ± 2 dB		
RF input			BNC 75 Ω coaxial socket		
RF input reducer			0 – 60 dB in 4 dB graduations		
Level measurement range			30–120 dB μ V		
Measurement bandwidth	SAT		6 MHz		
	SAT DVB		6 MHz		
	TV	250 kHz	TV/DVB	6 MHz	
	FM	250 kHz			
Measuring detector	SAT		Average value display		
	TV		Maximum value display		
	FM		Average value display		
Voltage standing wave ratio			> 6 dB		
FM threshold	SAT		< 9 dB		
Audio-IF bandwidth	SAT		230 kHz/150 kHz		
	TV		230 kHz		
	FM		230 kHz		
Audio Deemphasis	SAT		50 μ s		
	TV/FM		50 μ s		
Audio processing	SAT	FM audio processing	5.0 MHz...8.99 MHz in 10-kHz graduations		
	TV	FM and Nicam in quasi-parallel audio mode			
		AM in parallel audio mode (L standard only)			

Technical Data

	TV	B/G standard D/K standard I standard M/N standard M1 standard L standard B/G standard I standard	TT1 = 5.5 MHz, TT2 = 5.74 MHz TT1 = 6.5 MHz, TT2 = 6.26 MHz TT1 = 6.0 MHz TT1 = 4.5 MHz, TT2 = 4.72 MHz TT1 = 4.5 MHz AM 6.5 MHz, Nicam = 5.85 MHz Nicam = 5.85 MHz Nicam = 6.552 MHz
	FM	FM audio processing	48 MHz...858 MHz
Sound carrier measurement	TV	Standard B/G D/K standard I standard L standard M/N standard M1 standard	5.5 MHz, 5.74 MHz, 5.85 MHz 6.5 MHz, 6.26 MHz 6.0 MHz, 6.552 MHz 6.5 MHz, 5.85 MHz 4.5 MHz, 4.72 MHz 4.5 MHz
Nicam decoder Sound carrier distance	TV	5.58 MHz with B/G, D/K, L standards 6.552 MHz with I standard	
Nicam BER	TV	0-4 x 10 ⁻²	
DVB-S modulation method ¹⁾	QPSK		
DVB-C modulation method ¹⁾	64 QAM, 128 QAM, DOCSIS 64 QAM (MER and Offset only)		
DVB-T modulation method ¹⁾	OFDM, 2k, 8k, QPSK, 16 QAM, 64 QAM (Option)		
DVB-S-MER ¹⁾	-20 dB		
DVB-C-MER ¹⁾	-32 dB		
DVB-T-MER ¹⁾	-32 dB (Option)		
DVB-S-BER pre-Viterbi ¹⁾	0 – 2.8 x 10 ⁻²		
DVB-C-BER pre-Reed Solomon ¹⁾	0 – 2.8 x 10 ⁻²		
DVB-T-BER pre-Viterbi ¹⁾	0 – 2.8 x 10 ⁻² (Option)		
DVB-S carrier-offset-measurement ¹⁾			
DVB-C carrier-offset-measurement ¹⁾			
DVB-T carrier-offset-measurement ¹⁾	(Option)		
LNB supply voltage	SAT	0, 10 V...20 V, max. 500 mA	
External feeding voltage	TV	0, 5 V...9.9 V, max. 100 mA	
LNB control	SAT	22 kHz, 60 Hz, DiSEqC™, Simple DiSEqC™	
SCART output	1 V _{pp} /75 Ohm		

1) For measurements exceeding 100 dBμV please use the enclosed attenuation plug, as otherwise no video representation and no MER and BER measurements are possible.

Control Elements and Indicators

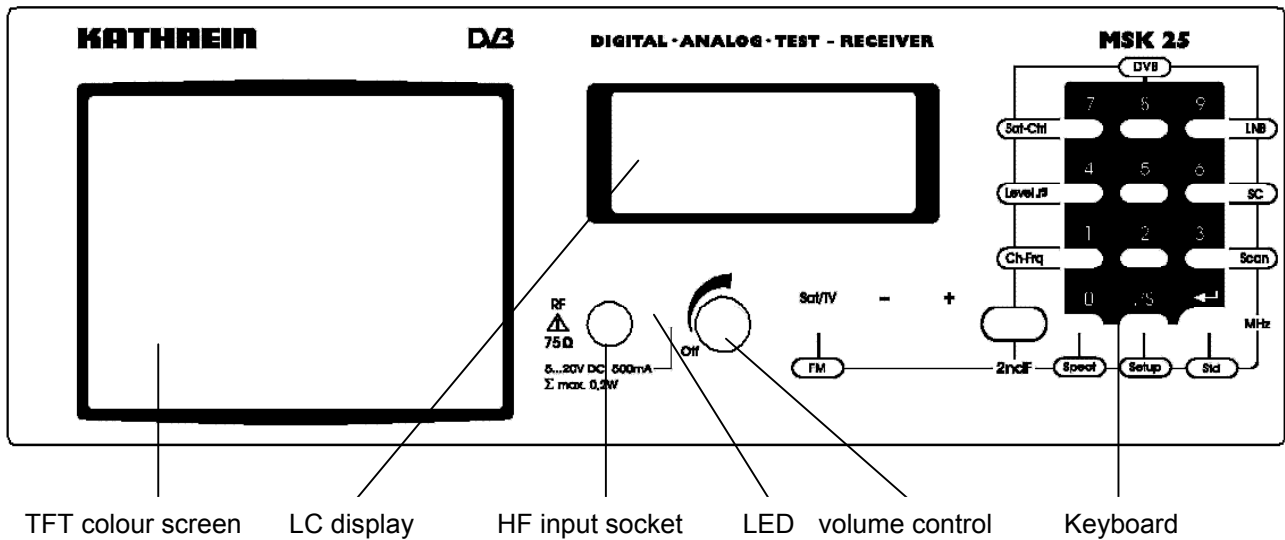

Control Elements

The following is displayed on the two-row 16 digit LC display, depending on the mode:

FR: 954.0 MHz	SAT
LEV: 40.0 dBuV	D

- the channel set,
- the frequency set,
- the function called up,
- the mode,
- the measured level
- the measured value

TFT Colour Screen

The colour screen has a diagonal of 4", a resolution of 238 x 480 pixel, and a luminance of 250 cd/m².

Connections (right hand side)

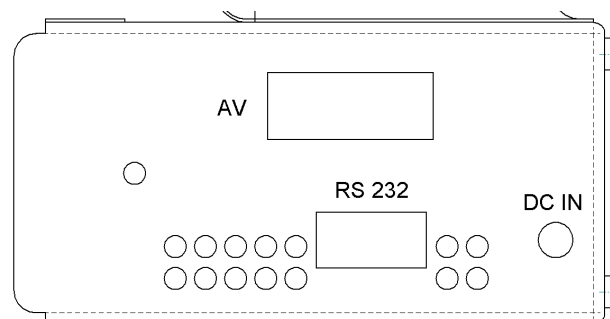

(AV) Scart connections without inputs, RS 232 interface,, supply voltage DC – for the power supply unit delivered only

Short Cut Overview

Key	Brief description of the various functions		
	SAT/DVB-S	TV/DVB-C/*DVB-T	FM
SAT/TV	Change-over to TV reception	Change-over SAT reception	Change-over to TV reception
-	Diminish current values		
+	Elevate current values		
0-9	Numeric character entry		
./S	Decimal point for numeric character entry	<ul style="list-style-type: none"> Decimal point for numeric character input Special channel call up 	Decimal point for numeric character input
ENTER	Confirm numeric character entry		

2ndF + key	Call-up of the second command level		
FM			Change-over to FM
Sat-Ctrl	Call-up of DiSEqC™ menu / LNB	Menu / Remote feeding	Call-up of DiSEqC™ menu / remote feeding
LNB	LNB voltage menu and current measurement	Remote feeding voltage and current measurement	Remote feeding voltage and current measurement
Ch-Freq	No function	<ul style="list-style-type: none"> Call-up of frequency menu Change-over from channel display to frequency display and reverse 	No function
Std	DVB-S/analogue change-over	DVB-C/*DVB-T/analogue-change-over standard-change-over	No function
DVB	DVB-S measurement MER, BER, OFFSET *MPEG programme selection	DVB-C/*DVB-T measurement MER, BER, OFFSET *MPEG programme selection	No
SC	(Subcarrier) sound carrier menu, sound carrier measurement		No function
Scan	Frequency-independent satellite search	No function	No function
Level 🎵	Switch-on level-dependent acoustic signal with bargraph display		
Spect	Spectrum analysis		
Setup	Adjustment of instrument settings		

* only if option is provided

Connections

RF Input Socket

The received signal of the antenna or of the cable network is fed in here (BNC coaxial socket).

The remote feeding voltage (for LNB) is adjustable from 5 V_{DC} to 20 V_{DC} and can be switched off. When the LNB voltage is switched on, the LED next to the RF input socket flashes.

Make sure that there are

- no voltage level over 120 dB μ V,
- no positive DC voltage over 22 V_{DC},
- no negative DC voltage and
- no AC voltage

adjacent to the RF input socket.

Non-compliance with these warning notices may destroy the input circuit.



External DC Voltage Supply

The MSK 25 may either be mains operated or battery operated (batteries built-in). The external voltage supply is carried out via the DC socket at the right side of the MSK 25 box, with the wall power supply and the charger, both included in delivery. Sustained continuous operation (incl. MPEG option) is possible in case of an LNB power consumption of no more than max. 300 mA. Additional current will be drained from the battery built-in if the power consumption is higher than that.

Make sure that

- only the wall power supply included in delivery is used.
- the wall power supply is not connected to the instrument but for voltage feed. Otherwise the battery of the MSK 25 will be discharged!



Scart Output

The video and audio signals are emitted on the Scart socket on the right hand side of the MSK 25, for rating purposes on an external monitor.

There are no inputs!

Misallocations of the connections may cause damage or destruction of the instrument!



RS 232 Interface

Software updates are possible via RS 232 interface.

Commissioning

Switching-Up

- Connect the instrument to the mains with the wall power supply.
- Turn the on/off switch to the right.
- Adjust the desired volume.

Software V2.0 SN: 000222

The LC display will then indicate the particular software version for appr. 1 second.

ACCU	[-----]
------	---------

Thereafter the LC display will indicate the loading capacity of the battery for appr. 3 seconds.

One segment comes up to appr. 20% of the overall capacity (3.4 Ah).

Now, feed in the reception signal of the receiving installation in the RF input socket.

LC display:

CH: .02.	TV
LEV: 48.5dBuV	A

- channel
- mode
- level (A = analogue level measurement; D = digital level measurement)

Select the desired mode by pressing **[TV/SAT]**

Switching-Off

Turn the on/off switch counter-clockwise.

Commissioning

Setup-Menu

The basic setting (status of the MSK 25 after switching it on) can be set in the Setup menu.

Factory Setting on Delivery

Parameter	Setting
POWER ON	TV
LNB DC	OFF
LEVEL	dB μ V
Low Level Mute	ON

Setup Menu Setting

Setup Menu Call-Up

Press **[2ndF]** and **[SETUP]**.

POWER ON
1=TV 2=SAT 3=FM

The particular mode (TV, SAT, FM) is selected and taken-over by pressing either **[1]**, **[2]** or **[3]**. The current setting is retained by pressing **[ENTER]**.

1. Setup menu

LNB DC
1=OFF 2=ON

The following requests appear:

Press either **[1]** or **[2]** to switch on/off the LNB voltage supply.

Press **[ENTER]** to retain the current setting.

2. Setup menu

Level
1=dB μ V 2=dBmV

Press either **[1]** or **[2]** to determine the measurement unit the level is to be displayed with.

Press **[ENTER]** to retain the current setting.

3. Setup menu

LOW LEVEL MUTE
1=OFF 2=ON

Set or offset the mute function by pressing either **[1]** or **[2]**. Select „ON“ to mute the MSK 25 until the input signal on the RF input exceeds 30 dB μ V.

Press **[ENTER]** to retain the desired setting.

CH: .07. TV
LEV: ____ dB μ V

Unless the factory settings have been changed, the indication opposite is displayed.

Basic setting

After setting the Low Level Mute, the 4th Setup menu will be exited automatically and the basic setting will be displayed.

Commissioning

Mains Operation and Battery Operation

The MSK 25 may either be mains operated or be battery operated (battery built-in).

Mains Operation



Only the wall power supply delivered may be used for power supply. Connect it to the voltage supply socket on the right hand side of the instrument.

Sustained continuous operation (incl. MPEG option) is possible in case of an LNB power consumption of no more than max. 300 mA. Additional current will be drained from the battery built-in if the power consumption is higher than that.

In case of any longer-lasting placing-out-of-operation, connect the MSK 25 to the mains supply occasionally (trickle charge).

Make sure that the wall power supply is not connected to the instrument but for voltage feed. Otherwise the battery of the MSK 25 will be discharged!

Battery Operation

Battery operation is only possible if the battery is sufficiently charged. Otherwise the MSK 25 cannot be switched on.

When completely discharged, the battery must immediately be recharged, since otherwise it may be damaged or destroyed.

Charging begins automatically as soon as the instrument has been connected to the mains supply. Battery supercharge is avoided with a protective circuit.

When switching on the MSK 25, the loading capacity of the battery is indicated for appr. 3 seconds.

The maximum operating time with a fully charged battery is appr. 2.5 hrs, in case of an LNB supply current of 150 mA.

SAT measurement

Standard Change-Over

In SAT mode, the MSK 25 receives

- analogue signals and
- DVB-S signals.

SAT Menu Standard Change-Over



[2ndF] [STD] calling up menu standard change-over:

[1] to [2] select standard

1 = analogue

2 = digital (DVB-S)

Examples



Calling up DVB-S standard

Press **[2ndF] [STD]**

The LC display indicates the following options:

- 1 = analogue standard
- 2 = digital (DVB-S) standard

1=ANALOGUE
2=DVBS

When selecting ,2' you will get to the symbol-rate-selection

The LC display indicates the following options:

Under the position 4=USER you can enter sample rates from 1,500 up to 32,000 ks and close with **ENTER**.

1=27500	2=24500
3=22000	4= USER

Standard menu

FR:1288.0MHz	SAT
LEV: 66.5dBuV	D

Display for DVB-S measurement

When you have selected an option, you will leave the standard menu and the instrument will be set to DVB measurement.

The display indicates 'D'.

SAT measurement

Frequency Display and Frequency Entry



To measure the level of a received signal, you must first enter the frequency required. The LC display indicates the frequency and the level measured. Frequency entry is possible from 920 MHz to 2150 MHz in 100 kHz steps.

SAT Menu Frequency Entry



[SAT/TV] Changing over to SAT reception

[0] to [9] Entering frequency

[+] [-] Varying frequency in 100 kHz steps

[ENTER] Confirming your entry

FR:1288.0MHz	SAT
LEV: 66.5dBuV	A

LC display:

- Frequency: 1288 MHz
- Mode: SAT
- Level: 66.5 dB μ V A (A = analogue)

Example



Enter the frequency 1508 MHz by pressing **[1] [5] [0] [8] [ENTER]**

FR:1508.0MHz	SAT
LEV: 86.5dBuV	A

LC display:

- frequency: 1508 MHz
- mode: SAT
- level: 86.5 dB μ V (A = analogue)

The indicator „+“ or „-“ on the display means that the MSK 25 has not been exactly tuned to the carrier required. Bei pressing either **[+] or [-]**, the frequency can be finetuned for optimum reception. This has been achieved when a vertical line appears on the display.

Note



Press **[ENTER]** to complete the frequency entry.

The last frequency entry will be retained even after you have switched off the MSK25, provided that the entry was carried out via numeric character input ending with ‚MHz‘

SAT measurement

SAT Analogue Level Measurement

Once you have entered a frequency, the level is measured automatically and displayed either in dB μ V or dBmV (depending on the basic configuration) on the LC display. The input level can be measured in the range of 30 dB μ V to 120 dB μ V (-30 dBmV to 60 dBmV).

LC display:

FR:1508.0MHz	SAT
LEV: 86.5dBuV	A

- Frequency: 1508 MHz
- Mode: SAT
- Level measured: 86.5 dB μ V A

Level Overflow and Level Underflow

FR:1508.0MHz	SAT
LEV: __. _dBuV	A

The LC display indicates underflow at a level of < 30 dB μ V.

The following indications appear on the display:

- frequency: 1508 MHz
- mode: SAT
- level: underflow

FR:1508.0MHz	SAT
LEV: ---. ---dBuV	A

The LC display indicates overflow at a level of > 120 dB μ V.

The following indications appear on the display:

- frequency: 1508 MHz
- mode: SAT
- level: overflow

Note



DVB-S signal levels can only be measured when the digital reception is set.

SAT DVB-S Level Measurement

LC display when the DVB-S level is measured:

The change-over from the analogue measurement to the digital level measurement is described in chapter ,standard change-over'

FR:1236.0MHz	SAT
LEV: 86.5dBuV	D

- Frequency 1236 MHz
- Mode: SAT DVB-S
- Level measured: 86.5 dB μ V D

SAT measurement

Locating Satellites

With the SCAN function, satellites, the exact transponder frequencies of which are unknown, can be located. In doing so, the frequency range from 1000 MHz to 2100 MHz is continuously scanned for received signals. If signals are received, the reception level is displayed as a bar graph. The measurement range may be adjusted to three different sensitivity levels.

The level can be monitored with an acoustic signal, the pitch of which is proportional to the received-signal level. The volume of the acoustic signal can be adjusted with the volume regulator.

SCAN Menu



[2ndF] [SCAN] Changing over to SCAN mode

[-] [+] Change-over of the bar graph measurement range.

Level range 1: high input levels

Levelrange 2: medium input levels

Level range 3: low input levels

[2ndF] [2ndF] Exit

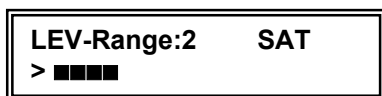

LC display:

- Level range 2: medium input level
- SAT mode
- Bargraph display

Example



Calling up SCAN mode:

- Press **[2ndF] [SCAN]**.
- Move the antenna until there is a level tendency visible on the bargraph display.
- Move the antenna until the maximum amplitude on the bargraph display is reached.
- If necessary, diminish or elevate the sensitivity by pressing either **[-]** or **[+]**.

Exit:

- Press **[2ndF]** twice.

SAT measurement

Bearing for Individual Reception Frequencies

The „LEVEL 🎵“ function allows the antenna alignment to maximum received signal via bearing. The level tendency can be bargraph-displayed. The measurement range can be adjusted to three different sensitivity levels.

The level can be monitored with an acoustic signal, the pitch of which is proportional to the received-signal level. The volume of the directional radio audio signal can be adjusted with the volume regulator.

Bearing Menu



[2ndF] [LEVEL 🎵] Changing over to bearing mode:

[-] [+] Change-over of the measurement range of the bar graph. The measurement range is automatically preselected.

Level range 1: high input levels

Level range 2: medium input levels

Level range 3: low input levels

[2ndF] [2ndF] Exit

LC display:

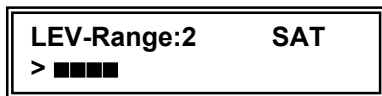

- Level range 2: medium input level
- Mode: SAT
- Bargraph display

Example

Calling up „LEVEL 🎵“ mode



Press **[2ndF] [LEVEL 🎵]**.

Move the antenna until the maximum amplitude of the bargraph display is reached.

If necessary, diminish or elevate the sensitivity by pressing either **[-]** or **[+]**.

Repeat this procedure until the maximum level is reached.

Exit:

Press **[2ndF]** twice.

SAT measurement

SAT Analogue Sound Carrier Frequency

Each video signal has several sound carrier frequencies assigned to it. Selective hearing of the sound maincarriers and the sound subcarriers is possible. The sound carrier frequency is tunable from 5.0 MHz to 8.99 MHz in 10 kHz steps. The soundcarrier bandwidth is automatically changed over from wide (280 kHz) to narrow (150 kHz) at 7.00 MHz.

The following sound carrier frequencies are factory-set:

key	Frequency in MHz	Bandwidth in kHz
[1]	5.80	280 wide
[2]	6.50	280 wide
[3]	6.65	280 wide
[4]	7.02	150 narrow
[5]	7.20	150 narrow
[6]	7.38	150 narrow
[7]	7.56	150 narrow
[8]	7.74	150 narrow
[9]	7.92	150 narrow

SAT Sound Carrier Frequencies Menu



- [2ndF] [SC]** Calling up sound carrier menu
- [1] to [9]** Selecting sound subcarrier (see table above)
- [-] or [+]** Varying sound carrier frequency in 10 kHz steps
- [ENTER]** Manually changing over sound carrier band width
wide = 280 kHz, narrow = 150 kHz
- [2ndF] [2ndF]** Exit

Example



Retrieving sound carrier 7.38 MHz:

Press **[2ndF] [SC] [6]**

LC display:

SC: 7,38MHz	SAT
BW:NARROW	

- Sound subcarrier: 7.38 MHz
- Sound carrier bandwidth: narrow = 150 kHz
- Mode: SAT

Note



After SAT mode has been called up, the MSK 25 will be permanently adjusted to sound carrier 7.02 MHz. Frequency variations of the sound carrier will not be retained after SAT mode has been closed.

SAT measurement

DVB-S MER, BER and Offset Measurement

The modulation error rate (MER), the bit error rate (BER) and the carrier offset can be measured to rate the digital reception quality. Chapter 'standard change-over' describes how to select between SAT/analogue and DVB-S.

Calling up DVB-S measurement:

Press **[2ndF] [DVB]** in SAT reception mode

LC display:

MER:12.6dB	MHz
BER:1.7e-7	+ 0.72

- (MER) modulation error rate: 12.6 dB
- (BER) bit error rate: 1.7e-7
- Carrier offset +0.72 MHz

In case there are no bit errors identified due to a strong DVB signal, **BER=0.0e+0** is indicated on the display.

MPEG Picture Representation (option) in DVB-S

After selecting DVB measurement by pressing **[2ndF] [DVB]**, the list of programmes received via digital transport data stream is displayed on the TFT screen.

Press **[+]** or **[-]** to select the desired programme and confirm your entry by pressing **[Enter]**.

In case of an FTA programme, picture and sound of the desired programme are decoded and represented or reproduced respectively via the loudspeaker which is built in.

Select another programme on the list by pressing **[Enter]** once more.

Press **[2ndF]** to exit digital reception.

Note



For measurements exceeding 100 dB μ V please use the enclosed attenuation plug, as otherwise no video representation and no MER and BER measurements are possible.

(Find indications on the frequency response of the enclosed attenuation plug on the last page)

SAT measurement

LNB Voltage and 22 kHz/60 Hz Change-Over

The LNB supply voltage can be obtained from the RF socket. For checking purposes, the LED beside the RF socket flashes when the voltage supply is switched on. The power consumption of the connected LNB is displayed on the LCD.

The additionally connectable 22 kHz square-wave signal or the 60 Hz square-wave signal respectively will superimpose the LNB voltage when connected. It is necessary, e. g., for the change-over of multifeed systems or high band/low band LNB's.

The LNB voltage is disengageable.

- Disengageable = 0 V
- Adjustable from 5 V to 20 V in 0.1 V steps
- Short-circuit proof (max. current 500 mA from 10 V to 20 V)
(max. current 100 mA from 5 to 9.9 V)

The following voltages can be called up via short cut:

key	LNB voltage
[0]	0 V
[1]	12 V
[2]	14 V
[3]	18 V
[5]	5 V
[7]	60 Hz
[8]	22 kHz

LNB Voltage Menu



- [2ndF] [LNB]** Calling up LNB menu
- [0] bis [5]** Selecting LNB voltage
- [-] oder [+]** Adjusting LNB voltage in 0.1 V steps
- [7]** 60 Hz signal on/off
- [8]** 22 kHz signal on/off
- [2ndF] [2ndF]** Exit

Examples



Calling up LNB voltage 14 V:

Press **[2ndF] [LNB] [2]**

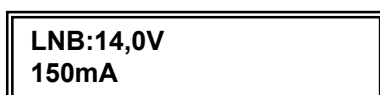

LC display:

- LNB voltage: 14 V
- Power consumption: 150 mA

Note



Press **[+]** or **[-]** to adjust the LNB voltage in 0.1 V steps.

By calling up a different function, e.g. **[2ndF] [CH-FRQ]**, the LNB menu will be closed automatically.

SAT measurement

Example



Activating the 22 kHz signal:

Press **[2nF] [LNB] [8]**

LNB:14,0V	22kHz
150mA	

LC display:

- LNB voltage: 14 V
- Power consumption: 150 mA
- 22 kHz signal activated

Note



By pressing **[8]** again, the 22 kHz signal can be deactivated.

By calling up a different function, e. g. **[2ndF] [CH-FRQ]** or **2x [2ndF]**, the LNB menu will be closed automatically.

SAT measurement

DiSEqC™ (Digital Satellite Equipment Control)

The DiSEqC™ system is used for control systems with extended control facilities. DiSEqC™ utilises a serial, bidirectional transmission mode with one master and one or more slaves. The data bits are generated with pulse width modulation of the 22 kHz carrier already existent, and are superimposed with 600 mV_{pp} of the LNB remote feeding voltage. The digital code words are composed of 8 data bits and one additional parity bit for the recognition of transmission errors. Several code words generate a DiSEqC™ command. The code word entry is to be effected in the hexadecimal code.

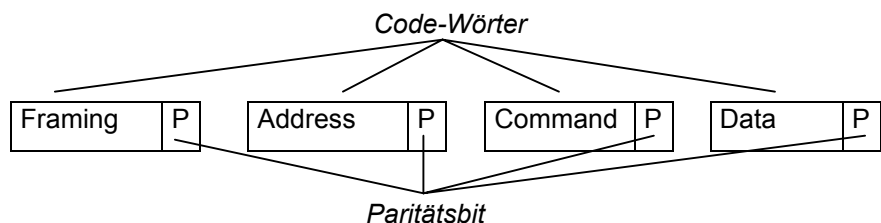

MSK 25 can emit signals to DiSEqC™1.0, however, it cannot receive signals.

DiSEqC™ Menu



[2ndF] [SAT-CTRL] Calling up DiSEqC™ menu

You will find the main DiSEqC™ commands for four satellite positions and the respective allocations of high and low band, as well as their appendant horizontal polarisation or vertical polarisation, displayed on the TFT screen.

[0] USER entry

[1] bis [8] Selection of the desired DiSEqC™ command

[9] Further DiSEqC™ commands or Simple DiSEqC™ commands

[ENTER] Sending the selected command string

USER entry

[0] to [9] Code word entry in hexadecimal code 0 to 9

[.] [0] to [5] Code word entry in hexadecimal code A.to.F

key	Hexadecimal code
[.] [0]	A
[.] [1]	B
[.] [2]	C
[.] [3]	D
[.] [4]	E
[.] [5]	F

[-] or [+] Moving the cursor to the individual code words: Framing, Address, Command and Data

[.] [6] Deleting the entire command string up to the cursor-position

[ENTER] Sending the command string

[2ndF] [2ndF] Exit

SAT measurement



Example for a USER entry

You wish to check the **EXR 22** KATHREIN matrix. The instruction set for the EXR 22 matrix is E0 00 24 (LNB High) and E0 00 20 (LNB Low).



SAT-CTRL menu

Calling up DiSEqC™:

Press **[2ndF] [SAT-CTRL]**

Press **[0]** to call up USER entry.



DiSEqC™ menu

You can now enter the individual code words by pressing **[0]** to **[9]** and **[./S]**. Press **[ENTER]** to send the command. „>“ signals the successful sending of the command.



DiSEqC™ menu

The instruction set to trigger the EXR 22 KATHREIN matrix has been entered and sent.

Note



Please find the DiSEqC™ instruction sets for KATHREIN matrices, Types EXR 20 and EXR 22 and for the 9xx production run in the technical appendix.

Framing Byte Menu



HEX Byte	description
E0	Command from master, nonrecurring transmission
E1	Command from master, recurrent transmission
E2	Command from master, response anticipated, first transmission
E3	Command from master, response anticipated, recurrent transmission
E4	Response from slave, „OK“, no errors recognised
E5	Response from slave, command not supported by slave
E6	Response from slave, parity error recognised
E7	Response from slave, command not identified

SAT measurement

Address Byte Menu



Hex Byte	Description
00	All instruments
10	Every LNB, Matrix or SMATV
11	LNB
12	LNB with loop-through
14	Matrix (Switcher)
15	Matrix (Switcher) with loop-through
18	SMATV
20	Every polarizer
21	Maximum turning (full skew) in linear polarisation
22	Stepwise polarizer adjustment
30	Every positioner
31	Polar/Azimuth positioner
32	Elevation positioner
33	Combined positioner
34	LNB Positioner
40	Set up help
41	Signal strength setting help
60	Reserved for assigned addresses
70	„Intelligent slave interface“ for „Proprietary Multi-Master bus“
71	Interface for users and controlled head-end
Fx	OEM expansion

SAT measurement

Command Byte Menu



MSK 25 can send commands under DiSEqC™ 1.0 but cannot receive them. All the commands requiring DiSEqC™ 2.0 (sending and receiving) are underlined **grey** in the table below.

Commands in bold are particularly preferred for KATHREIN switching matrices.

Hex Byte	Command	Description	Number of data bytes
00	Reset	Reset DiSEqC™ Microcontroller	-
01	Clr Reset	Delete reset flag	-
02	Stand-by	Switching off peripheral power supply unit	-
03	Power on	Switching on peripheral power supply unit	-
04	Set Contend	Adjustment of contention flag	-
05	Contend	Feedback only if contention flag has been set	-
06	Clr Contend	Delete contention flag	-
07	Adresse	Feedback only if contention flag has not been set	-
08	Move C	Change address when contention flag has been set	1
09	Move	Change address when contention flag has not been set	1
10	Status	Read status register flags	-
11	Config	Read configuration flags	-
14	Switch 0	Read switching status flags (Committed Port)	-
15	Switch 1	Read switching state flags (Uncommitted Port)	-
16	Switch 2	Expansion option	-
17	Switch 3	Expansion option	-
20	Set LO	Calling up of low local oscillator frequency	-
21	Set VR	Calling up the vertical polarisation or clockwise circular polarisation	-
22	Set Pos A	Select satellite position A	-
23	Set S0A	Select switchoption A	-
24	Set Hi	Calling up of high local oscillator frequency	-
25	Set HL	Calling up of horizontal polarisation or counter-clockwise circular polarisation	-
26	Set Pos B	Select Satellitenposition B	-
27	Set S0B	Select switchoption B	-
28	Set S1A	Calling up of matrix S1 input A (input B inactive)	-
29	Set S2A	Calling up of matrix S2 input A (input B inactive)	-
2A	Set S3A	Calling up of matrix S3 input A (input B inactive)	-
2B	Set S4A	Calling up of matrix S4 input A (input B inactive)	-
2C	Set S1B	Calling up of matrix S1 input B (input A inactive)	-
2D	Set S2B	Calling up of matrix S2 input B (input A inactive)	-
2E	Set S3B	Calling up of matrix S3 input B (input A inactive)	-
2F	Set S4B	Calling up of matrix S4 input B (Eingang A inactive)	-
30	Sleep	All bus commands ignored, except „Awake“	-
31	Awake	Bus commands again accepted	-
38	Write N0	Setting Port Group 0	1
39	Write N1	Setting Port Group 1	1
3A	Write N2	Expansion option	1
3B	Write N3	Expansion option	1
40	Read A0	Read analogue value A0	-
41	Read A1	Read analogue value A1	-
48	Write A0	Set analogue value A0	1
49	Write A1	Set analogue value A1	1

SAT measurement

4F	Write A7	Set analogue value A7	1
50	LO string	Read current frequency	-
51	LO now	Read current frequency (Table Entry Number)	-
52	LO Lo	Read Lo frequency table entry number	-
53	LO Hi	Read Hi frequency table entry number	-
58	Write Freq	Write channel frequency	2 or 3
59	Ch.No.	Set selected channel number (receiver)	2
60	Halt	Stop positioner	-
61	Go E	Move positioner eastward	-
62	Go W	Move positioner westward	-
64	P Status	Read positioner status register	-
65	Read Pos	Read positioner counter	-
6C	Goto	Move positioner motor to counter value, Hi, Lo	2
6D	Write Pos	Set positioner counter, Hi, Lo	2

SAT measurement

Data Byte Menu



A corresponding data byte need not be sent to a command byte unless required by the command byte data byte(s). You can see this from the preceding command byte table. Please learn from the data sheets of the respective instruments which data byte is to be sent to the particular command byte.

Orbit-position	Switch setting H/V	Switch setting LNB	Data byte
1	V	Lo	F0
	V	Hi	F1
	H	Lo	F2
	H	Hi	F3
2	V	Lo	F4
	V	Hi	F5
	H	Lo	F6
	H	Hi	F7
3	V	Lo	F8
	V	Hi	F9
	H	Lo	FA
	H	Hi	FB
4	V	Lo	FC
	V	Hi	FD
	H	Lo	FE
	H	Hi	FF

Simple Tone Burst DiSEqC™

A simplified version of the DiSEqC™ control is the Simple Tone Burst DiSEqC™ procedure. Simple DiSEqC™ allows two different switching states: Tone Burst and Data Burst.

Simple DiSEqC™ Menu



- [2ndF] [SAT-CTRL]** Call- up SAT-CTRL menu
- [9] [9]** Call-up Simple-DiSEqC™ menu
- [0]** Tone Burst entry
- [1]** Data Burst entry
- [ENTER]** Sending of command string
- [2ndF] [2ndF]** Exit

TV measurement

Standard Change-Over

In TV mode, the MSK 25 can measure the following standards:

- B/G standard
- L standard
- D/K standard
- I standard
- M/N standard
- M1 standard (Japan)

Standard Change-Over TV Menu



[2ndF] [STD] Calling up standard change-over menu

[0] Addressing standard menu

[0] bis [6] Selecting standard

Example



Calling up B/G analogue standard:

Press **[2ndF] [STD]**.

LC display:

1=ANALOG	3=DVBT
2=DVBC	0=Std.

- 1 = Analogue reception
- 2 = DVB-C reception
- 3 = DVB-T reception (if this option is provided)
- **0 = standard menu**

Press **[0]**.

The following menu is displayed:

1=BG	2=L	3=DK
4=I	5=MN	6=M1

- 1 = B/G standard- 2 = L standard - 3 = D/K standard etc.

Standard menu

Press **[1]**. The instrument is now set for analogue reception in the B/G standard

Note



Please note that the selected standard will be retained after the instrument has been switched off.

TV measurement

DVB-C/DVB-T Change-Over

Press **[2ndF] [STD]**.

1=ANALOG	3=DVBT
2=DVBC	0=Std.

LC display:

- 1 = Analogue reception
- 2 = DVB-C reception
- 3 = DVB-T reception (if this option is provided)
- 0 = Standard menu

Press **[2]** to change over to DVB-C standard

LC display:

1=QAM64	2=QAM128
3=DOC64	

- 1 = QAM 64 demodulation
- 2 = QAM 128 demodulation
- 3 = DOCSIS QAM 64 demodulation

Press **[1]** to set the QAM 64 symbol rate

1=6.900	2=6.952
3=6.875	4=USER

LC display:

- 1 = 6.900 MS
- 2 = 6.952 MS
- 3 = 6.875 MS
- 4 = USER MS

Select the corresponding symbol rate by pressing the corresponding key **[1] [4]**.

The standard setting will then automatically be closed.

TV measurement

Channel display and channel entry

You first have to set the required channel to be able to measure the level of a TV reception signal. The following channels may be set:

- Band /III CH 01 to CH 12 in 7 MHz raster
- Band IV/V CH 21 to CH 70 in 8 MHz raster
- Special channel S 02 to S 03 in 8 MHz raster
- Special channel S 04 to S 20 in 7 MHz raster
- Special channel S 21 to S 41 in 8-MHz raster

This information applies only for the factory-set B/G standard. Please find more information on further standards in the technical appendix.

TV Channel Setting Menu



- [SAT/TV]** Changing over to TV reception
- [0] bis [9]** Setting channel
- [./S]** Changing over to special channel
- [+] und [-]** Varying channels stepwise

Example



Setting channel S11:

Press **[./S] [1] [1]**.

LC display:

CH:S.11.	TV
LEV: 62,5dBuV	A

- Special channel: S 11
- Level: 62,5 dB μ V
- Mode: TV analog

Note



Make sure that the correct standard has been set. B/G standard is factory-set.

TV measurement

Frequency Display and Frequency Entry

You first have to enter the required picture carrier frequency to be able to measure the level of a TV reception signal.

Frequency entry is possible from 48 MHz to 858 MHz in 50 kHz steps.

TV Frequency Entry Mode



- [SAT/TV]** Changing over to TV reception
- [CH-FRQ]** Change-over channel/frequency
- [0] bis [9]** Entering frequency
- [ENTER]** Confirming entry
- [+] und [-]** Varying frequency stepwise

Example



Entering frequency 175.25 MHz:

Press **[2ndF] [CH/FRQ]**(frequency menu call up)

Then press **[1] [7] [5] [./S] [2] [5] [ENTER]**(frequency entry)

LC display:

CH:175,25	TV
LEV: 65,0dBuV	A

- Frequency: 175.25 MHz
- Level: 65.0 dB μ V
- Mode: TV analogue

Note



If you had called up the frequency menu before, you now only need to enter the figures in order to enter a frequency.

The last frequency entry will be retained even after you have switched off the MSK 25, provided that the entry was carried out via numeric character input, ending with ,MHz'

TV measurement

Level Measurement TV Analogue

After you have set a channel or a frequency, the level is automatically measured and displayed on the LC display either in dB μ V or in dBmV (depending on the basic configuration). The input level can be measured in the range of 30 dB μ V to 120 dB μ V (-30 dBmV to 60 dBmV).

LC display:

CH: .05.	TV
LEV: 86.5dBuV	A

- Channel: CH 05
- Mode: TV analogue
- Level measured: 86.5 dB μ V

Level Overflow and Level Underflow

The LC display indicates underflow at a level of < 30 dB μ V.

LC display:

CH: .05.	TV
LEV: __. __dBuV	A

- Channel: CH 05
- Mode: TV analogue
- Level: underflow

The LC display indicates overflow at a level of > 120 dB μ V.

LC display:

CH: .05.	TV
LEV: ---dBuV	A

- Channel: CH 05
- Mode: TV analogue
- Level: overflow

Note



DVB-C signals can only be measured if „digital reception“ has been set, see chapter ‚standard change-over‘.

TV/DVB-C/DVB-T Level Measurement

LC display when the DVB-C/DVB-T levels are measured:

CH:S.32.	TV
LEV: 64.0dBuV	D

The change-over from the analogue measurement to the digital level measurement is described in chapter ‚standard change-over‘

- Channel: Special channel 32
- Mode: TV/DVB-C or DVB-T
- Level measured: 64.0 dB μ V D

TV measurement

Bearing for Individual Reception Frequencies

The „LEVEL “ function allows the antenna alignment to maximum received signal via bearing. The level tendency can be bargraph-displayed. The measurement range can be adjusted to three different sensitivity levels.

The level can be monitored with an acoustic signal, the pitch of which is proportional to the received-signal level. The volume of the directional radio audio signal can be adjusted with the volume regulator.

Bearing Menu



[2ndF] [LEVEL  Changing over to bearing mode:

[-] [+] Change-over of the measurement range of the bar graph. The measurement range is automatically preselected.

Level range 1: high input levels

Level range 2: medium input levels

Level range 3: low input levels

[2ndF] [2ndF] Exit

LC display:



- Level range 2: medium input level
- Mode: TV
- Bargraph display

Example



Calling up „LEVEL “ mode:

Press **[2ndF] [LEVEL **.

Move the antenna until the maximum amplitude of the bargraph display is reached.

If necessary, diminish or elevate the sensitivity by pressing either **[-]** or **[+]**.

Repeat this procedure until the maximum level is reached.

Closing LEVEL mode:

Press **[2ndF]** twice.

TV measurement

Sound Carrier Distance and Sound Carrier Level

On a second sound carrier, TV broadcast stations can transmit either frequency-modulated (analogue) or in Nicam format (digital). Depending on the standard which has been set, various frequencies are assigned to the sound carriers, see table. Sound carrier 1 is permanently set after the channel entry or frequency entry.

Standard	TT1	TT2	Nicam
B/G	5.5 MHz	5.74 MHz	5.85 MHz
D/K	6.5 MHz	6.26 MHz	5.85 MHz
I	6.0 MHz	-----	6.552 MHz
M/N	4.5 MHz	4.72 MHz	-----
L	AM 6.5 MHz	-----	5.85 MHz
M1 (Japan)	4.5 MHz	-----	-----

The sound carrier measurement is carried out by measuring the signal distance from the sound carrier to the picture carrier in dB before measuring the absolute sound carrier in dB μ V. The loudspeaker remains muted during this procedure. When the measurement has been effected, the modulation of the sound carrier last measured can be heard.

TV Sound Carrier Measurement Menu



- [2ndF] [SC]** Changing over to sound carrier menu:
- [1] bis [2]** Change-over between TT1 and TT2, see table
Measurement is carried out when key is pressed
- [3]** Change-over to Nicam reception

Example



SC: 5,50MHz	TV
LEV: -13.0dB	A

- Measuring sound carrier distance and sound carrier level of TT1:
Press **[2ndF] [SC]**,
now press **[1]** and keep the key pressed.
The LC display will indicate the following values for appr. 1 second:
- Sound carrier distance – frequency: 5.5 MHz
 - Sound carrier – picture carrier distance: -13 dB
 - Mode: TV analogue

After about 1 second, the sound carrier level will be indicated.

SC: 5,50MHz	TV
LEV: 58,5dBuV	A

- LC display:
- Sound carrier distance – frequency: 5.5 MHz
 - Sound carrier level: 58.5 dB μ V
 - Mode: TV analogue

Release key **[1]**.

Measuring sound carrier distance and sound carrier level of TT2:

Press **[2]** while the sound carrier is displayed

Measuring the distances and the levels of Nicam sound carriers:

TV measurement

Press **[3]** while the sound carrier is displayed

Note



The sound carrier frequency is not adjustable but changed over according to the standard which has been set.

The sound carrier level is only displayed when key **[2]** or **[3]** is pressed.

NICAM Sound Bit Error Rate Measurement

The bit error rate may be measured for an improved evaluation of the Nicam signal sound quality.

Example



SC: 5.85 MHz	TV
BER=2.145E-05	

Calling up bit error measurement:

Press **[2ndF] [SC]**

Press **[3]**

In case there are no bit errors identified due to a strong signal, **BER=0.000** is indicated on the display.

In case there is hardly a signal or no signal at all received, **OVERFLOW** is indicated on the display.

TV measurement

DVB-C/DVB-T (option), MER, BER and Offset Measurement

The modulation error rate (MER), the bit error rate (BER) and the carrier offset can be measured to evaluate the quality of the digital reception.

Chapter 'standard change-over' describes how to select either TV analogue, DVB-C or optionally DVB-T.

Calling up DVB-C/DVB-T (option) measurement:

Press **[2ndF] [DVB]**

LC display:

MER:30.5dB	MHz
BER:2.0e-8	0.00

- Modulation error rate (MER): 30.5 dB
- Bit error rate (BER): 2.0e-8
- Carrier offset: 0.00 MHz

In case there are no bit errors identified due to a strong DVB signal **BER=0.0e+0** is indicated.

MPEG Picture Representation (option) in DVB-C or DVB-T (option)

After selecting DVB measurement by pressing **[2ndF] [DVB]**, the list of programmes received via digital transport data stream is displayed on the TFT screen.

Press **[+]** bzw. **[-]** to select the desired programme and confirm your entry by pressing **[Enter]**.

In case of an FTA programme, picture and sound of the desired programme are decoded and represented or reproduced respectively via the loudspeaker which is built in.

Select another programme of the list by pressing **[Enter]** once more.

Press [2ndF] to exit digital reception.

Note



For measurements exceeding 100 dB μ V please use the enclosed attenuation plug, as otherwise no video representation and no MER and BER measurements are possible.

(Find indications on the frequency response of the enclosed attenuation plug on the last page)

FM measurement

Frequency Indication and Frequency Entry

You first have to enter the desired frequency to be able to measure the level of an FM reception signal.

Frequency entry is possible from 48 MHz to 858 MHz in 50 kHz steps.

FM Frequency Entry Menu



- [2ndF] [FM]** Changing over to FM reception
- [0] bis [9]** Entering frequency
- [ENTER]** Confirming entry
- [+] und [-]** Varying frequency in 50 kHz steps

Example



Entering frequency 99.25 MHz:

Press **[2ndF] [FM]**.....(Call up FM menu)

Then press **[9] [9] [./S] [2] [5] [ENTER]**(frequency entry)

LC display:

FR: 99.25	FM
LEV: 65.0dBuV	A

- Frequency: 99.25 MHz
- Level: 65.0 dB μ V
- Mode: FM

Note



If you had called up the FM menu before, you now only need to enter the figures in order to enter a frequency.

The last frequency entry will be retained even after you have switched off the MSK 25, provided that the entry was carried out via numeric character input, ending with ,MHz'.

FM measurement

Level Measurement

After you have set a frequency, the level is automatically measured and displayed in dB μ V. The input level can be measured in the range of 30 dB μ V to 120 dB μ V.

LC display:

Fr:104.80MHz	FM
LEV: 86.5dBuV	A

- Frequency: 104.8 MHz
- Mode: FM
- Level measured: 86.5 dB μ V

Level Overflow and Level Underflow

The LC display indicates underflow at a level of < 30 dB μ V.

LC display:

FR:104.80MHz	FM
LEV: ____dBuV	A

- Frequency: 104.8 MHz
- Mode: FM
- Level: underflow

The LC display indicates overflow at a level of > 120 dB μ V.

LC display:

FR:104,80MHz	FM
LEV: ____dBuV	A

- Frequency: 104.8 MHz
- Mode: TV
- Level: overflow

FM measurement

Bearing for Individual Reception Frequencies

The „LEVEL “ function allows the antenna alignment to maximum received signal via bearing. The level tendency can be bargraph-displayed. The measurement range can be adjusted to three different sensitivity levels.

The level can be monitored with an acoustic signal, the pitch of which is proportional to the received-signal level. The volume of the acoustic signal can be adjusted with the volume regulator.

Bearing Menu



- | | |
|--|---|
| [2ndF] [LEVEL  | Changing over to bearing mode |
| [-] [+] | Change-over of the measurement range of the bar graph. The measurement range is automatically preselected.

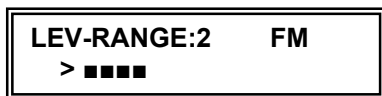

Level range 1: high input levels
Level range 2: medium input levels
Level range 3: low input levels |
| [2ndF] [2ndF] | Exit |



- LC display:
- Level range 2: medium input level
 - Mode: TV
 - Bargraph display

Example



- Calling up „LEVEL “ function:
Press **[2ndF] [LEVEL **.
- Move the antenna until the maximum amplitude of the bargraph display is reached.
- If necessary, diminish or elevate the sensitivity by pressing either **[-]** or **[+]**
- Repeat this procedure until the maximum level is reached.

Closing LEVEL mode:

Press **[2ndF]** twice.

Spectrum Measurement

The frequency spectrum in the SAT, TV and FM modes may be displayed on the TFT screen for evaluation purposes.

You can call up the function 'spectrum measurement' in each particular mode (SAT, TV, FM).

Command for 'spectrum measurement': **[2ndF] [Spect]**.

Back to the regular LC display: 2 x **[2ndF]**.

By pressing **[-]** and **[+]**, you can move a cursor ∇ on the level curve in order to measure certain level minima and level maxima. The frequency and the value measured are displayed in the top row of the screen. The measurement range is displayed in dB μ V on the ordinate on the left hand side of the screen. The level measurement range is set automatically.

The level peak value is measured in the spectrum analysis.

SAT Spectrum

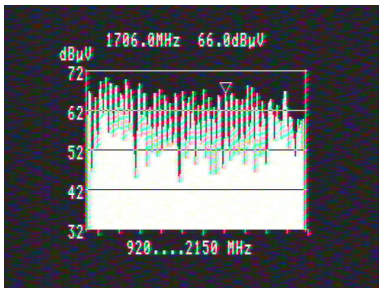

In SAT mode (see corresponding chapter), the entire SAT spectrum from 920 MHz.....2150 MHz can be displayed.



LC display

TV Spectrum



The TV mode (see corresponding chapter) is divided into four ranges which can be selected by pressing either **[1]**, **[2]**, **[3]** or **[4]**, see screen as well as explanation shown below.

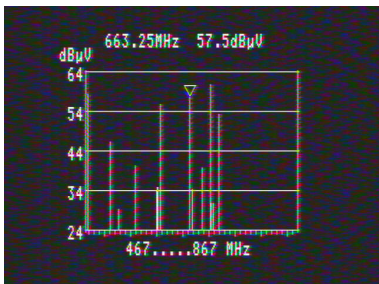

Example for UHF

Spectrum Measurement

TV Spectrum Menu



LC displays and range setting:

TV-Full

[1] FULL SPAN = overall TV range (48...858 MHz)

VHF

[2] VHF (48...467 MHz)

UHF

[3] UHF (467...858 MHz)

TV-Narrow

[4] NARROW (634...659 MHz)

FM Spectrum

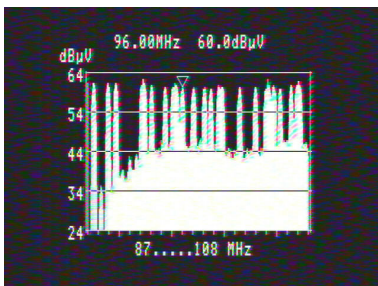

The FM spectrum is addressed and measured as described above. It ranges from 87 MHz to 108 MHz.

FM CCIR

LC display

Maintenance

Changing the Battery



- Unscrew the two screws which fix the straps on the leather bag. Then unscrew the screw in the leather cap. Pull the receiver out of the leather bag.
- Now unscrew all the screws atop, at the bottom and on every side of the metal box. Pull the receiver out of it.
- Unscrew the two screws on the left and on the right of the DVB 25 circuit board mounting, and turn the DVB 25 circuit board upright.
- Disconnect the battery poles. Beware of causing a short circuit between the insulated terminal and the battery mount.
- Unscrew the four screws of the battery mount beneath the chassis.
- Pull the battery backwards out of the instrument.
- Fit in the new battery and reassemble the instrument in reverse order. Make sure that the polarity of the battery is correct!

Customer Service

In case of any damage or malfunction, please send the MSK 25 to:

ESC - GmbH
Bahnhofstraße 108
83224 GRASSAU

Tel.: +49 (0)86 41 / 95 45-0
Fax: +49 (0)86 41 / 95 45-35

Technical Appendix

Signal-to-Noise-Ratio

The following values must be known in order to determine the carrier/signal-to-noise-ratio (C/N):

- Basic noise level (adjust the dish antenna so that no satellite signal will be received)
- Maximum reception level
- Bandwidth correction

The following formula applies:

$$C/N = \text{Received signal level} - \text{Basic signal-to-noise-ratio} - \text{Bandwidth correction}$$

$$\text{Bandwidth correction value} = 10 \log \frac{6 \text{ MHz (Measurement bandwidth MSK 25)}}{\text{RF bandwidth received signal}}$$

Bandwidth correction value = 6.37 dB at 26 MHz bandwidth (ASTRA)

Bandwidth correction value = 7.78 dB at 36 MHz (EUTELSAT, INTELSAT, Kopernikus)

Example



Received-signal level	+75.5 dB	With satellite signal
Basic signal-to-noise-ratio	<u>-55.0 dB</u>	Without satellite signal
Carrier/signal-to-noise-ratio (C/N)	+20.5 dB	
Bandwidth correction	- 6.4 dB	For 26 MHz bandwidth
C/N of reception system	<u>+14.1 dB</u>	

Note



It is essential to consider the RF bandwidth of the received signal in order to be able to accurately determine the C/N.

Technical Appendix

DiSEqC™ Commands for Kathrein Matrices

Instruction Set for 9xx Kathrein Matrix Production Run

Range	POS. A (Satellit 1)			
	Low-Band		High-Band	
	Vert.	Horiz.	Vert.	Horiz.
DiSEqC™ Command	F0 00 38 F0	F0 00 38 F2	F0 00 38 F1	F0 00 38 F3

Range	POS. B (Satellit 2)			
	Low-Band		High-Band	
	Vert.	Horiz.	Vert.	Horiz.
DiSEqC™ Command	F0 00 38 F4	F0 00 38 F6	F0 00 38 F5	F0 00 38 F7

Instruction Set for EXR 20 Kathrein Matrix

Range	EXR 20	
	POS. A	POS. B
DiSEqC™ Command	E0 00 22	E0 00 26

Instruction Set for EXR 22 Kathrein Matrix

Range	EXR 22	
	High-band	Low-band
DiSEqC command	E0 00 24	E0 00 20

Technical Appendix

Channel Tables

Channel Table and Frequency Table B/G Standard (frequencies in MHz)

VRF-CCIR			URF-CCIR			URF-CCIR			
Pilot frequency	01	80.15	21	21	471.25	46	46	671.25	
E2	02	48.25	22	22	479.25	47	47	679.25	
E3	03	55.25	23	23	487.25	48	48	687.25	
E4	04	62.25	24	24	495.25	49	49	695.25	
E5	05	17.25	25	25	503.25	50	50	703.25	
E6	06	182.25	26	26	511.25	51	51	711.25	
E7	07	189.25	27	27	519.25	52	52	719.25	
E8	08	196.25	28	28	527.25	53	53	727.25	
E9	09	203.25	29	29	535.25	54	54	735.25	
E10	10	210.25	30	30	543.25	55	55	743.25	
E11	11	217.25	31	31	551.25	56	56	751.25	
E12	12	224.25	32	32	559.25	57	57	759.25	
A	13	53.75	33	33	567.25	58	58	767.25	
B	14	62.25	34	34	575.25	59	59	775.25	
C	15	82.25	35	35	583.25	60	60	783.25	
D	16	175.25	36	36	591.25	61	61	791.25	
E	17	183.75	37	37	599.25	62	62	799.25	
F	18	192.25	38	38	607.25	63	63	807.25	
G	19	201.25	39	39	615.25	64	64	815.25	
H	20	210.25	40	40	623.25	65	65	823.25	
			41	41	631.25	66	66	831.25	
			42	42	639.25	67	67	839.25	
			43	43	647.25	68	68	847.25	
			44	44	655.25	69	69	855.25	
			45	45	663.25				
LSB/USB			ESB			¹⁾ In the FRG the special DVB-C channels S02 and S03 were allocated with a bandwidth of 8 MHz. The center frequencies now are: S02 = 113 MHz and S03 = 121 MHz.			
S01	S01	105.25	ES21	S21	303.25				
S02 ¹⁾	S02	113.00	ES22	S22	311.25				
S03 ¹⁾	S03	121.00	ES23	S23	319.25				
S04	S04	126.25	ES24	S24	327.25				
S05	S05	133.25	ES25	S25	335.25				
S06	S06	140.25	ES26	S26	343.25				
S07	S07	147.25	ES27	S27	351.25				
S08	S08	154.25	ES28	S28	359.25				
S09	S09	161.25	ES29	S29	367.25				
S10	S10	168.25	ES30	S30	375.25				
S11	S11	231.25	ES31	S31	383.25				
S12	S12	238.25	ES32	S32	391.25				
S13	S13	245.25	ES33	S33	399.25				
S14	S14	252.25	ES34	S34	407.25				
S15	S15	259.25	ES35	S35	415.25				
S16	S16	266.25	ES36	S36	423.25				
S17	S17	273.25	ES37	S37	431.25				
S18	S18	280.25	ES38	S38	439.25				
S19	S19	287.25	ES39	S39	447.25				
S20	S20	294.25	ES40	S40	455.25				
			ES41	S41	463.25				
Channel raster: 7 MHz for VHF and LSB/USB - 8 MHz for UHF and ESB Find channels, display indications on the MSK 25 and frequencies, all on the table									

Technical Appendix

Channel Table and Frequency Table L Standard (frequencies in MHz)

VHF			UHF			UHF		
	01	80.75	21	21	471.25	46	46	671.25
* LB	02	55.75	22	22	479.25	47	47	679.25
* LC	03	60.50	23	23	487.25	48	48	687.25
* LC1	04	63,75	24	24	495.25	49	49	695.25
L1	05	176.00	25	25	503.25	50	50	703.25
L2	06	184.00	26	26	511.25	51	51	711.25
L3	07	192.00	27	27	519.25	52	52	719.25
L4	08	200.00	28	28	527.25	53	53	727.25
L5	09	208.00	29	29	535.25	54	54	735.25
L6	10	216.00	30	30	543.25	55	55	743.25
	11	308.75	31	31	551.25	56	56	751.25
	12	441.75	32	32	559.25	57	57	759.25
	13	861.75	33	33	567.25	58	58	767.25
K ₁₄	14	175.25	34	34	575.25	59	59	775.25
K ₁₅	15	183.25	35	35	583.25	60	60	783.25
K ₁₆	16	191.25	36	36	591.25	61	61	791.25
K ₁₇	17	199.25	37	37	599.25	62	62	799.25
K ₁₈	18	207.25	38	38	607.25	63	63	807.25
K ₁₉	19	215.25	39	39	615.25	64	64	815.25
	20	223.25	40	40	623.25	65	65	823.25
			41	41	631.25	66	66	831.25
			42	42	639.25	67	67	839.25
			43	43	647.25	68	68	847.25
			44	44	655.25	69	69	855.25
			45	45	663.25			
Special channels								
			S01	S01	120.00	S21	S21	280.00
			S02	S02	128.00	S22	S22	288.00
			S03	S03	136.00	S23	S23	303.25
			S04	S04	144.00	S24	S24	315.25
			S05	S05	152.00	S25	S25	327.25
			S06	S06	160.00	S26	S26	339.25
			S07	S07	168.00	S27	S27	351.25
			S08	S08	176.00	S28	S28	363.25
			S09	S09	184.00	S29	S29	375.25
			S10	S10	192.00	S30	S30	387.25
			S11	S11	200.00	S31	S31	399.25
			S12	S12	208.00	S32	S32	411.25
			S13	S13	216.00	S33	S33	423.25
			S14	S14	224.00	S34	S34	435.25
			S15	S15	232.00	S35	S35	447.25
			S16	S16	240.00	S36	S36	459.25
			S17	S17	248.00			
			S18	S18	256.00			
			S19	S19	264.00			
			S20	S20	272.00			
No picture and sound evaluation possible as well as no level measurement of the sound carrier for the channels marked with *.								
Find channels, display indications on the MSK 25 and frequencies, all on the table.								

Technical Appendix

Channel Table and Frequency Table D/K Standard (frequencies in MHz)

VHF			UHF			UHF		
R-I	01	49.75	21	21	471.25	46	46	671.25
R-II	02	59.75	22	22	479.25	47	47	679.25
R-III	03	77.25	23	23	487.25	48	48	687.25
R-IV	04	85.25	24	24	495.25	49	49	695.25
R-V	05	93.52	25	25	503.25	50	50	703.25
R-VI	06	175.25	26	26	511.25	51	51	711.25
R-VII	07	183.25	27	27	519.25	52	52	719.25
R-	08	191.25	28	28	527.25	53	53	727.25
R-IX	09	199.25	29	29	535.25	54	54	735.25
R-X	10	207.25	30	30	543.25	55	55	743.25
R-XI	11	215.25	31	31	551.25	56	56	751.25
R-XII	12	223.25	32	32	559.25	57	57	759.25
	13	50.00	33	33	567.25	58	58	767.25
	14	60.00	34	34	575.25	59	59	775.25
	15	70.00	35	35	583.25	60	60	783.25
	16	75.00	36	36	591.25	61	61	791.25
	17	80.00	37	37	599.25	62	62	799.25
	18	90.00	38	38	607.25	63	63	807.25
	19	175.00	39	39	615.25	64	64	815.25
	20	200.00	40	40	623.25	65	65	823.25
			41	41	631.25	66	66	831.25
			42	42	639.25	67	67	839.25
			43	43	647.25	68	68	847.25
			44	44	655.25	69	69	855.25
			45	45	663.25			
			Special channels					
			S01	S01	111.25	S21	S21	311.25
			S02	S02	119.25	S22	S22	319.25
			S03	S03	127.25	S23	S23	327.25
			S04	S04	135.25	S24	S24	335.25
			S05	S05	143.25	S25	S25	343.25
			S06	S06	151.25	S26	S26	351.25
			S07	S07	159.25	S27	S27	359.25
			S08	S08	167.25	S28	S28	367.25
			S09	S09	100.25	S29	S29	375.25
			S10	S10	105.25	S30	S30	383.25
			S11	S11	231.25	S31	S31	391.25
			S12	S12	239.25	S32	S32	399.25
			S13	S13	247.25	S33	S33	407.25
			S14	S14	255.25	S34	S34	415.25
			S15	S15	263.25	S35	S35	423.25
			S16	S16	271.25	S36	S36	431.25
			S17	S17	279.25	S37	S37	439.25
			S18	S18	287.25	S38	S38	447.25
			S19	S19	295.25	S28	S28	455.25
			S20	S20	303.25	S40	S40	463.25
Find channels, display indications on the MSK 25 and frequencies, all on the table.								

Technical Appendix

Channel Table and Frequency Table I Standard (frequencies in MHz)

VHF			UHF			UHF		
I A	01	45.75	21	21	471.25	46	46	671.25
I B	02	53.75	22	22	479.25	47	47	679.25
I C	03	61.75	23	23	487.25	48	48	687.25
I D	04	175.25	24	24	495.25	49	49	695.25
I E	05	183.25	25	25	503.25	50	50	703.25
I F	06	191.25	26	26	511.25	51	51	711.25
I G	07	199.25	27	27	519.25	52	52	719.25
I H	08	207.25	28	28	527.25	53	53	727.25
I J	09	215.25	29	29	535.25	54	54	735.25
	10	223.25	30	30	543.25	55	55	743.25
	11	231.25	31	31	551.25	56	56	751.25
	12	239.25	32	32	559.25	57	57	759.25
	13	247.45	33	33	567.25	58	58	767.25
	14	50.00	34	34	575.25	59	59	775.25
	15	60.00	35	35	583.25	60	60	783.25
	16	70.00	36	36	591.25	61	61	791.25
	17	75.00	37	37	599.25	62	62	799.25
	18	80.00	38	38	607.25	63	63	807.25
	19	90.00	39	39	615.25	64	64	815.25
	20	175.00	40	40	623.25	65	65	823.25
			41	41	631.25	66	66	831.25
			42	42	639.25	67	67	839.25
			43	43	647.25	68	68	847.25
			44	44	655.25	69	69	855.25
			45	45	663.25			
			Special channels					
			S01	S01	111.25	S21	S21	311.25
			S02	S02	119.25	S22	S22	319.25
			S03	S03	127.25	S23	S23	327.25
			S04	S04	135.25	S24	S24	335.25
			S05	S05	143.25	S25	S25	343.25
			S06	S06	151.75	S26	S26	351.25
			S07	S07	159.25	S27	S27	359.25
			S08	S08	167.25	S28	S28	367.25
			S09	S09	100.25	S29	S29	375.25
			S10	S10	105.25	S30	S30	383.25
			S11	S11	231.25	S31	S31	391.25
			S12	S12	239.25	S32	S32	399.25
			S13	S13	247.25	S33	S33	407.25
			S14	S14	255.25	S34	S34	415.25
			S15	S15	263.25	S35	S35	423.25
			S16	S16	271.25	S36	S36	431.25
			S17	S17	279.25	S37	S37	439.25
			S18	S18	287.25	S38	S38	447.25
			S19	S19	295.25	S28	S28	455.25
			S20	S20	303.25	S40	S40	463.25
Find channels, display indications on the MSK 25 and frequencies, all on the table.								

Technical Appendix

Channel Table and Frequency Table M1 Standard (Japan) (frequencies in MHz)

VHF			UHF			UHF		
J01	01	91.25	13	13	471.25	38	38	621.25
J02	02	97.25	14	14	477.25	39	39	627.25
J03	03	103.25	15	15	483.25	40	40	633.25
J04	04	171.25	16	16	489.25	41	41	639.25
J05	05	177.25	17	17	495.25	42	42	645.25
J06	06	183.25	18	18	501.25	43	43	651.25
J07	07	189.25	19	19	507.25	44	44	657.25
J08	08	193.25	20	20	513.25	45	45	663.25
J09	09	199.25	21	21	519.25	46	46	669.25
J10	10	205.25	22	22	525.25	47	47	675.25
J11	11	211.25	23	23	531.25	48	48	681.25
J12	12	217.25	24	24	537.25	49	49	687.25
			25	25	543.25	50	50	693.25
			26	26	549.25	51	51	699.25
			27	27	555.25	52	52	705.25
			28	28	561.25	53	53	711.25
			29	29	567.25	54	54	717.25
			30	30	573.25	55	55	723.25
			31	31	579.25	56	56	729.25
			32	32	585.25	57	57	735.25
			33	33	591.25	58	68	741.25
			34	34	597.25	59	59	747.25
			35	35	603.25	60	60	753.25
			36	36	609.25	61	61	759.25
			37	37	615.25	62	62	765.25
Special channels								
S 1	S01	223.25	S20	S20	337.25	S39	S39	451.25
S 2	S02	231.25	S21	S21	343.25	S40	S40	457.25
S 3	S03	237.25	S22	S22	349.25	S41	S41	463.25
S 4	S04	243.25	S23	S23	355.25			
S 5	S05	249.25	S24	S24	361.25			
S 6	S06	253.25	S25	S25	367.25	M 1	S42	109.25
S 7	S07	259.25	S26	S26	373.25	M 2	S43	115.25
S 8	S08	265.25	S27	S27	379.25	M 3	S44	121.25
S 9	S09	271.25	S28	S28	385.25	M 4	S45	127.25
S10	S10	277.25	S29	S29	391.25	M 5	S46	133.25
S11	S11	283.25	S30	S30	397.25	M 6	S47	139.25
S12	S12	289.25	S31	S31	403.25	M 7	S48	145.25
S13	S13	295.25	S32	S32	409.25	M 8	S49	151.25
S14	S14	301.25	S33	S33	415.52	M 9	S50	157.25
S15	S15	307.25	S34	S34	421.25	M10	S51	165.25
S16	S16	313.25	S35	S35	427.25			
S17	S17	319.25	S36	S36	433.25			
S18	S18	325.25	S37	S37	439.25			
S19	S19	331.25	S38	S38	445.25			
Find channels, display indications on the MSK 25 and frequencies, all on the table.								

Technical Appendix

Channel Table and Frequency Table M/N Standard (frequencies in MHz)

VHF		UHF		UHF				
01	72.00	14	14	471.25	47	47	669.25	
A02	02	55.25	15	15	477.25	48	48	675.25
A03	03	61.25	16	16	483.25	49	49	681.25
A04	04	67.25	17	17	489.25	50	50	687.25
A05	05	77.25	18	18	495.25	51	51	693.25
A06	06	83.25	19	19	501.25	52	52	699.25
A07	07	175.25	20	20	507.25	53	53	705.25
A08	08	181.25	21	21	513.25	54	54	711.25
A09	09	187.25	22	22	519.25	55	55	717.25
A10	10	193.25	23	23	525.25	56	56	723.25
A11	11	199.25	24	24	531.25	57	57	729.25
A12	12	205.25	25	25	537.25	58	58	735.25
A13	13	211.25	26	26	543.25	59	59	741.25
			27	27	549.25	60	60	747.25
			28	28	555.25	61	61	753.25
			29	29	561.25	62	62	759.25
			30	30	567.25	63	63	765.25
			31	31	573.25	64	64	771.25
			32	32	579.25	65	65	777.25
			33	33	585.25	66	66	783.25
			34	34	591.25	67	67	789.25
			35	35	597.25	68	68	795.25
			36	36	603.25	69	69	801.25
			37	37	609.25	70	70	807.25
			38	38	615.25	71	71	813.25
			39	39	621.25	72	72	819.25
			40	40	627.25	73	73	825.25
			41	41	633.25	74	74	831.25
			42	42	639.25	75	75	837.25
			43	43	645.25	76	76	843.25
			44	44	651.25	77	77	849.25
			45	45	657.25	78	78	855.25
			46	46	663.25			

Find channels, display indications on the MSK 25 and frequencies, all on the table.

Technical Appendix

Channel Table and Frequency Table M/N Standard (frequencies in MHz)

Special channels					
A-5	95	S01	91.25	OO 51	S43 385.25
A-4	96	S02	97.25	PP 52	S44 391.25
A-3	97	S03	103.25	QQ 53	S45 397.25
A-2	98	S04	109.25	RR 54	S46 403.25
A-1	99	S05	115.25	SS 55	S47 409.25
A	14	S06	121.25	TT 56	S48 415.25
B	15	S07	127.25	UU 57	S49 421.25
C	16	S08	133.25	VV 58	S50 427.25
D	17	S09	139.25	WW 59	S51 433.25
E	18	S10	145.25	AAA 60	S52 439.25
F	19	S11	151.25	BBB 61	S53 445.25
G	20	S12	157.25	CCC 62	S54 451.25
H	21	S13	163.25	DDD 63	S55 457.25
I	22	S14	169.25	EEE 64	S56 463.25
J	23	S15	217.25	65	S57 469.25
K	24	S16	223.25	66	S58 475.25
L	25	S17	229.25	67	S59 481.25
M	26	S18	235.25	68	S60 487.25
N	27	S19	241.25	69	S61 493.25
O	28	S20	247.25	70	S62 499.25
P	29	S21	253.25	71	S63 505.25
Q	30	S22	259.25	72	S64 511.25
R	31	S23	265.25	73	S65 517.25
S	32	S24	271.25	74	S66 523.25
T	33	S25	277.25	75	S67 529.25
U	34	S26	283.25	76	S68 535.25
V	35	S27	289.25	77	S69 541.25
W	36	S28	295.25	78	S70 547.25
AA	37	S29	301.25	79	S71 553.25
BB	38	S30	307.25	80	S72 559.25
CC	39	S31	313.25	81	S73 565.25
DD	40	S32	319.25	82	S74 571.25
EE	41	S33	325.25	83	S75 577.25
FF	42	S34	331.25	84	S76 583.25
GG	43	S35	337.25	85	S77 589.25
HH	44	S36	343.25	86	S78 595.25
II	45	S37	349.25	87	S79 601.25
JJ	46	S38	355.25	88	S80 607.25
KK	47	S39	361.25	89	S81 613.25
LL	48	S40	367.25	90	S82 619.25
MM	49	S41	373.25	91	S83 625.25
NN	50	S42	379.25	92	S84 631.25
			93	S85	637.25

Find channels, display on the MSK 25 and frequencies, all on the table.

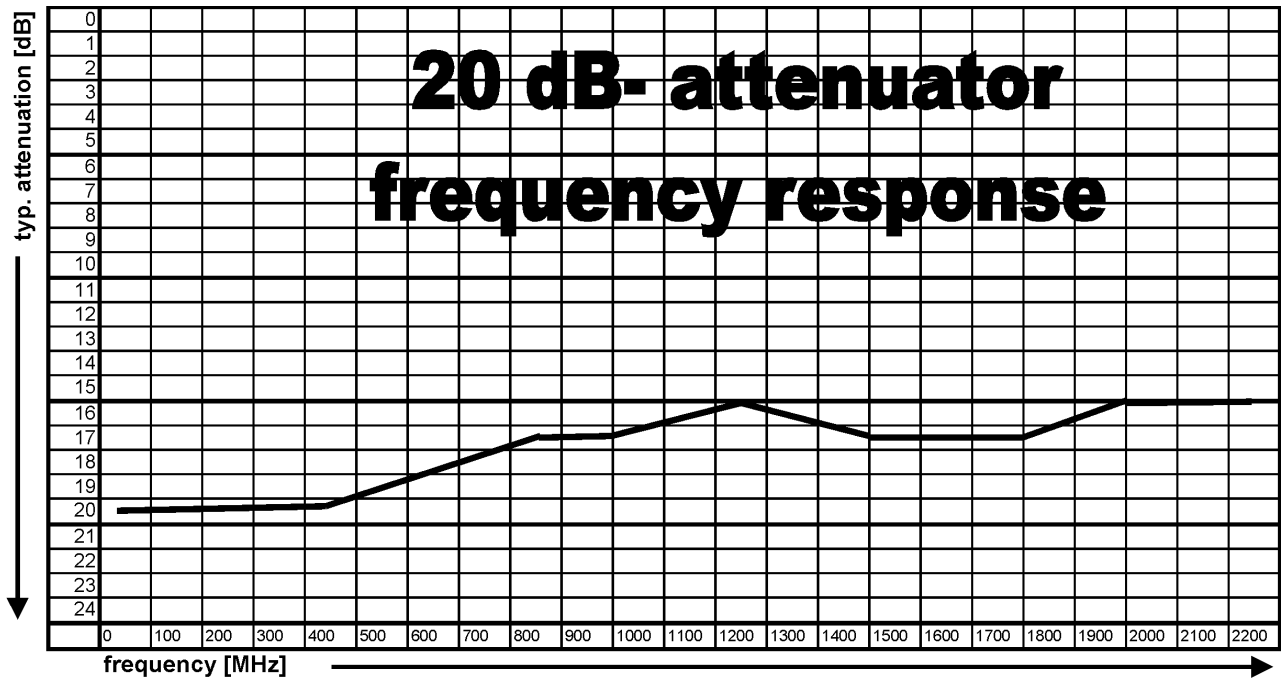

936.2642/D/1005/ZWT Subject to technical modifications.